

Machine Dimensions and Specifications

Model HT200N 200lb. Capacity Athletic Drying Tumbler
Natural Gas or Propane Gas Heat Source



Equipment specifications are subject to change without notice.

Dimensions

A	32.1 [815]	J	8.0 [205]
B	34.0 [865]	K	14.6 [370]
C	55.8 [1420]	L	94.0 [2390]
D	59.3 [1505]	M	60.8 [1545]
E	77.3 [1965]	N	77.4 [1965]
F	75.0 [1905]	O	8.8 [225]
G	63.7 [1620]	P	11.0 [280]
H	34.3 [870]	Q	52.9 [1345]
I	32.7 [830]	R	36 [910]
in. [mm]			

Specifications

Net Weight (approximate): Pounds [kg]	1550 [705]
Required Make-Up Air Opening (to the outside) for Each Tumble Dryer, in. ² [cm ²]	525 [3400]
Maximum Airflow: C.F.M. [l/sec]	2150 [1,010]
Maximum Static Back Pressure: Inch W.C. [mbar, kPa]	0.80 [2.0, 0.20]
Gas Burner Rating: Btu/hr. [kW, Mj/hr.]	425,000 [125, 448]

Electrical Specifications

Code	Voltage	Cycle	Phase	Wire	Full Load Amps	Circuit Breaker	Wire Size AWG [mm ²]
Q	200-240	50-60	3	L1, L2, L3 and ground	12	15	14 [2.5]
N	440-480	50-60	3	L1, L2, L3 and ground	6	15	14 [2.5]

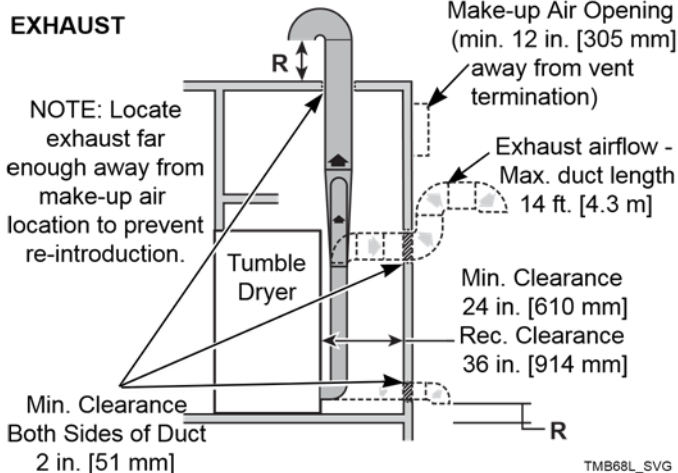
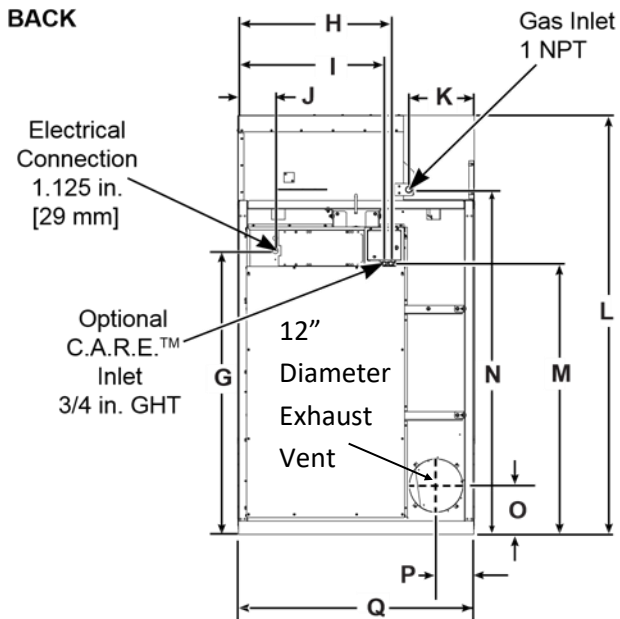
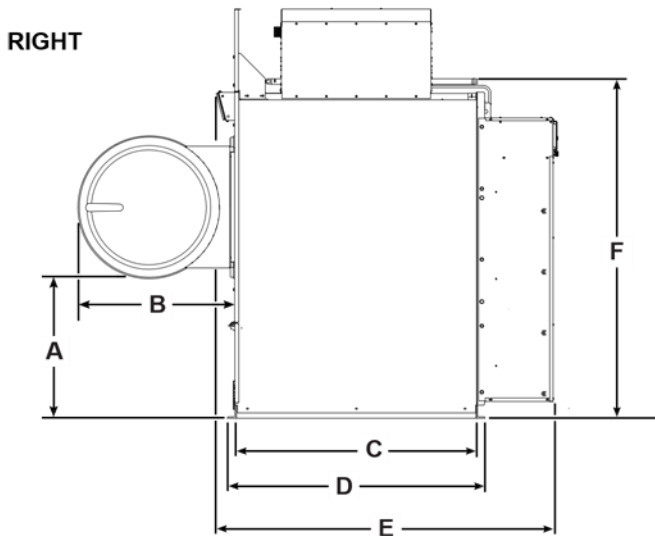

TMB68L_SVG

WWW.ATHLETICLS.COM

1-800-327-4782

SALES@ATHLETICLS.COM